

























# ODKVAPOVÝ SYSTÉM

# CENNÍK

				POVRCHOVÁ ÚPRAVA				
				Pozink. plech +Akzonobel		Aluzinok - prírodný		
		MJ	rozmer	€/MJ bez DPH	€/MJ s DPH	€/MJ bez DPH	€/MJ sDPH	
<b>ŽLAB POD ODKVAPOVÝ</b> L=2000/4000mm		B01	bm	125	4,00	4,80	2,16	2,59
				150	4,60	5,52	2,86	3,43
<b>ŽLABOVÝ ROH VNÚTORNÝ 90°</b>		B02	ks	125	8,45	10,14	4,23	5,08
				150	8,61	10,33	5,82	6,98
<b>ŽLABOVÝ ROH VONKAJŠÍ 90°</b>		B03	ks	125	8,45	10,14	4,23	5,08
				150	8,61	10,33	5,82	6,98
<b>ŽLABOVÉ ČELO DOPREDAJ*</b>		B04	ks	125	1,93	2,32	0,96	1,15
				150	2,03	2,44	1,30	1,56
<b>ŽLABOVÉ ČELO MASLEN</b>		B04	ks	125	1,35	1,62	0,95	1,14
				150	1,40	1,68	1,00	1,20
<b>ŽLABOVÝ HÁK L=330mm DOPREDAJ*</b>		B06	ks	125	2,35	2,82	1,90	2,28
				150	2,75	3,30	2,35	2,82
<b>ŽLABOVÝ HÁK s nosom L=300mm</b>		B06N	ks	125	2,00	2,40	1,55	1,86
				150	2,40	2,88	2,00	2,40
<b>ŽLABOVÝ HÁK s nosom L=350mm</b>		B06N	ks	125	2,40	2,88	1,85	2,22
				150	2,80	3,36	2,30	2,76
<b>ŽLABOVÝ HÁK s plieškom L=300mm</b>		B06P	ks	125	2,25	2,70	1,90	2,28
				150	2,65	3,18	2,35	2,82
<b>ŽLABOVÝ HÁK s plieškom L=350mm</b>		B06P	ks	125	2,65	3,18	2,10	2,52
				150	3,05	3,66	2,55	3,06
<b>ŽLABOVÝ HÁK MASLEN do čelovej dosky</b>		B10	ks	125	1,60	1,92	1,40	1,68
				150	2,00	2,40	1,70	2,04
<b>ŽLABOVÝ HÁK MASLEN s nosom do čelovej dosky</b>			ks	125	1,50	1,80	1,30	1,56
				150	1,90	2,28	1,60	1,92
<b>ŽLABOVÝ HÁK KOMPAKT na odkvap. dosku DOPREDAJ*</b>		B10	ks	125	2,02	2,42	1,65	1,98
				150	2,43	2,92	2,21	2,65
<b>ŽLABOVÁ SPOJKA</b>		B11	ks	125	2,05	2,46	1,12	1,34
				150	2,90	3,48	2,13	2,56
<b>ŽLABOVÝ KOTLÍK</b>		B12	ks	125	4,19	5,03	2,88	3,46
				150	5,00	6,00	4,16	4,99
<b>LAPAČ LÍSTIA pozinkovaný</b>		B13	ks	UNI	-	-	2,99	3,59
<b>ŽLABOVÝ ÚCHYT UNI</b>		B14	ks	UNI	1,00	1,20	0,80	0,96
<b>DOČASNÝ ZVOD fóliový rukáv z PE</b>		B20	bm	UNI	0,25	0,30	-	-
<b>ZVODOVÁ RÚRA L=1000/3000MM</b>		B21	bm	87	4,80	5,76	2,50	3,00
				97	5,10	6,12	3,19	3,83
<b>KOLENO ZVODOVEJ RÚRY 60°</b>		B22	ks	87	4,40	5,28	2,50	3,00
				97	5,30	6,36	3,73	4,48
<b>REDUKCIA</b>		B24	ks	97	4,20	5,04	3,10	3,72
<b>ZACHYTÁVAČ VODY</b>		B27	ks	87	28,60	34,32	27,00	32,40
				97	36,00	43,20	31,50	37,80
<b>ZVODOVÁ ODBOČKA</b>		B28	ks	87	23,55	28,26	17,99	21,59
				97	26,49	31,79	21,38	25,66
<b>OBJÍMKA ZVODOVEJ RÚRY - nová</b>		B26L	ks	87	3,05	3,66	2,70	3,24
				97	3,10	3,72	2,80	3,36
<b>KOMBISKRUTKA S HMOŽ. DO MURIVA</b>				€/MJ bez DPH		€/MJ s DPH		
<b>M8X80/12X60</b>				ks	0,25	0,30		
<b>M8X140/12X120</b>				ks	0,35	0,42		
<b>M8X200/12X180</b>				ks	0,41	0,49		
<b>M8X250/12X180</b>				ks	0,52	0,62		
<b>M8X300/12X180</b>				ks	0,64	0,77		
<b>HMOŽDINKA DO ZATEPLENEJ FASÁDY - min. zateplenie 100mm</b>								
<b>HD2F 12X100</b>				ks	1,19	1,43		
<b>NIT trhací 4,0x8 (rôzne farby)</b>								
				ks	0,07	0,08		

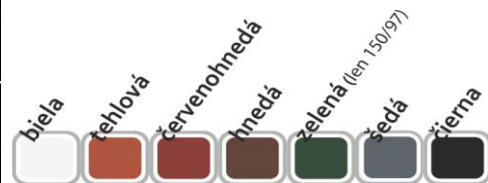
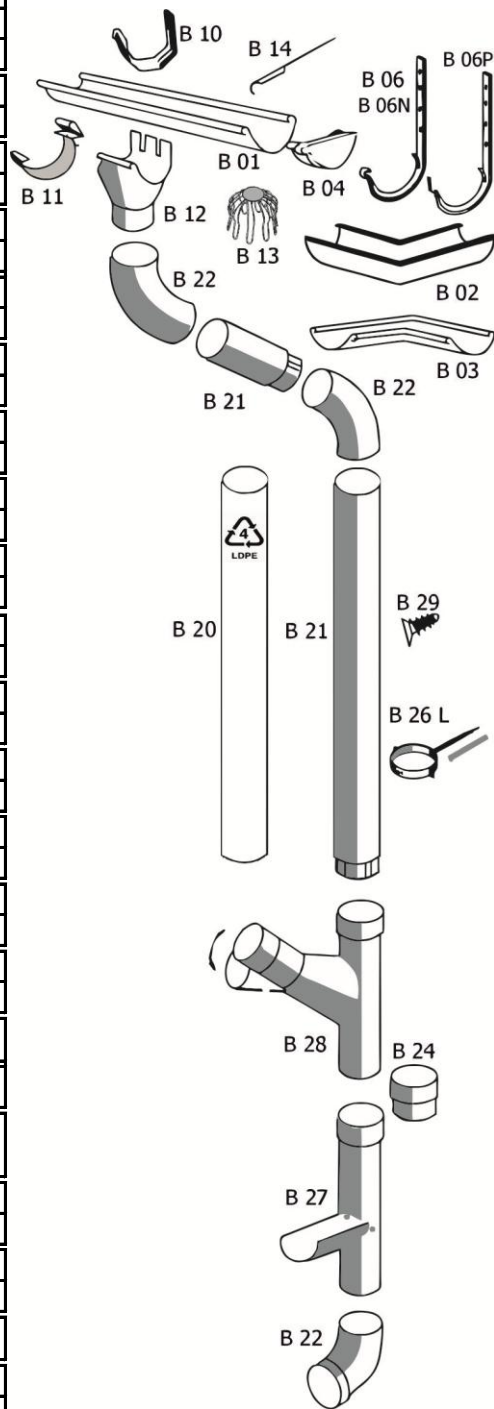

\* dopredaj skladových zásob



Cenník platný od 22.04.2020 DPH 20%

Slovenský výrobca strešných krvtín a trapézových plechov Badín 655, 976 32 Badín - centrála a výroba

www.maslen.sk